

Standard Anschlusstypen:

A \updownarrow 435÷1635, B \leftrightarrow 230÷530:

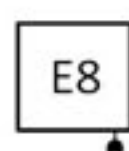
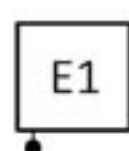
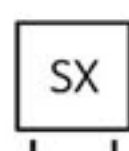

Weitere mögliche Anschlusstypen:

A \updownarrow 435÷1635, B \leftrightarrow 230÷530:

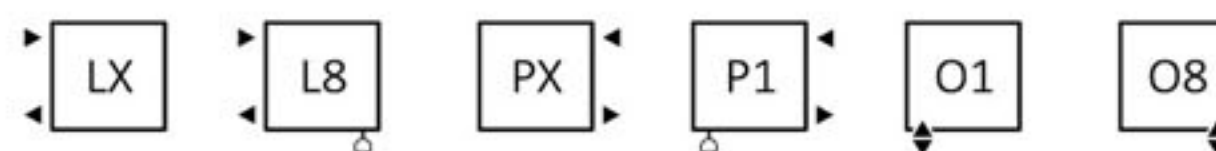

A \updownarrow 435÷1635, B \leftrightarrow 430÷530:

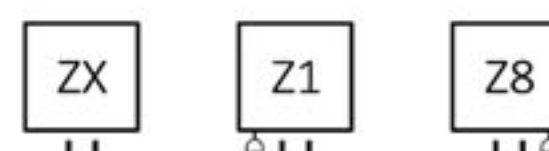

A \updownarrow 735÷1635, B \leftrightarrow 230÷530:

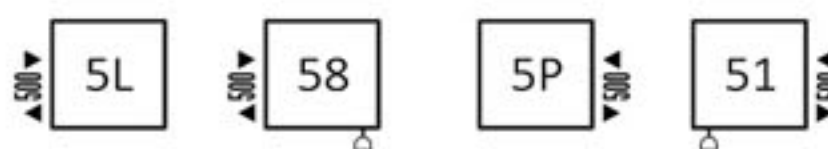

Technische Daten:



Betriebsdruck: 1000 kPa Maximale Betriebstemperatur: 95°C

A \updownarrow [mm]	B \leftrightarrow [mm]	C2 [mm]	75/65/20°C [W]	55/45/20°C [W]	☉ [W]	D [mm]	E [mm]	F [mm]	H [dm³]	📏 [kg]
Pulverlack										
435	430	400	203	106	200	400	255	90	1,25	3,62
435	530	500	245	128	300	500	255	90	1,41	4,28
460	230	200	122	64	120	200	280	90	0,92	2,24
710	230	200	185	97	200	200	530	90	1,40	3,38
735	430	400	337	176	400	400	555	90	2,07	5,92
735	530	500	406	213	400	500	555	90	2,34	6,99
960	230	200	247	130	300	200	780	90	1,89	4,52
1035	430	400	466	245	400	400	855	90	2,89	8,21
1035	530	500	563	295	600	500	855	90	3,26	9,69
1210	230	200	308	162	300	200	1030	90	2,38	5,66
1335	430	400	593	312	600	400	1155	90	3,71	10,51
1335	530	500	715	376	800	500	1155	90	4,19	12,40
1460	230	200	367	193	400	200	1280	90	2,86	6,80
1635	430	400	716	377	800	400	1455	90	4,53	12,81
1635	530	500	864	454	800	500	1455	90	5,11	15,11
1710	230	200	425	224	400	200	1530	90	3,35	7,94

Mike

Datenblatt 2



A ↓ [mm]	B ↔ [mm]	C2 [mm]	75/65/20°C [W]	55/45/20°C [W]	 [W]	D [mm]	E [mm]	F [mm]	 [dm³]	 [kg]
Galvanische Oberfläche										
435	430	400	142	72	120	400	255	90	1,25	3,48
435	530	500	171	87	200	500	255	90	1,41	4,11
460	230	200	85	44	120	200	280	90	0,92	2,16
710	230	200	130	66	120	200	530	90	1,40	3,25
735	430	400	236	120	200	400	555	90	2,07	5,68
735	530	500	284	145	300	500	555	90	2,34	6,71
960	230	200	173	88	200	200	780	90	1,89	4,35
1035	430	400	326	167	300	400	855	90	2,89	7,89
1035	530	500	394	201	400	500	855	90	3,26	9,31
1210	230	200	216	110	200	200	1030	90	2,38	5,45
1335	430	400	415	212	400	400	1155	90	3,71	10,09
1335	530	500	501	255	600	500	1155	90	4,19	11,90
1460	230	200	257	131	300	200	1280	90	2,86	6,54
1635	430	400	501	256	600	400	1455	90	4,53	12,30
1635	530	500	605	308	600	500	1455	90	5,11	14,50
1710	230	200	298	152	300	200	1530	90	3,35	7,64

Verfügbare Größen:

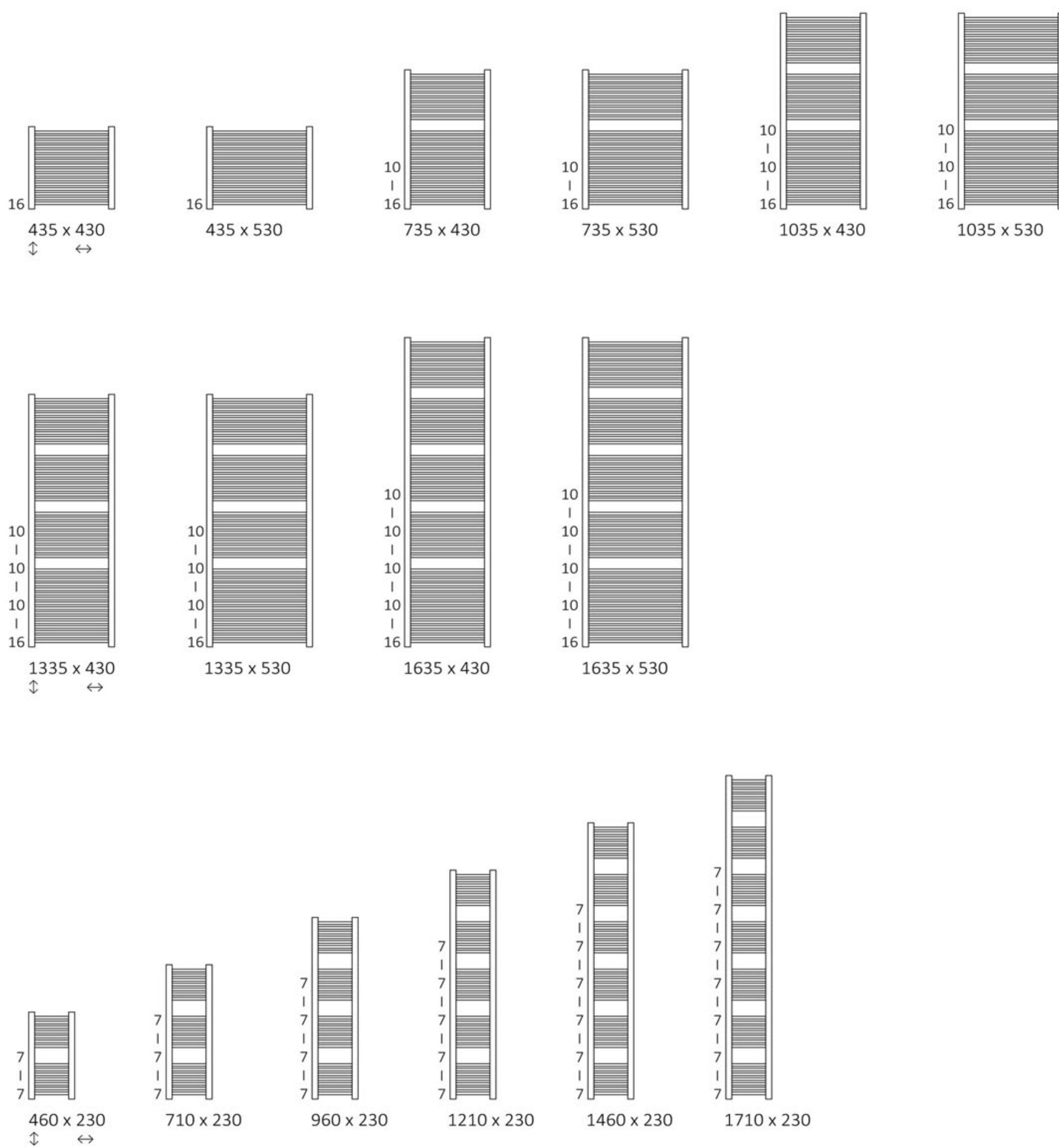

Mike

Technische Zeichnung



SX

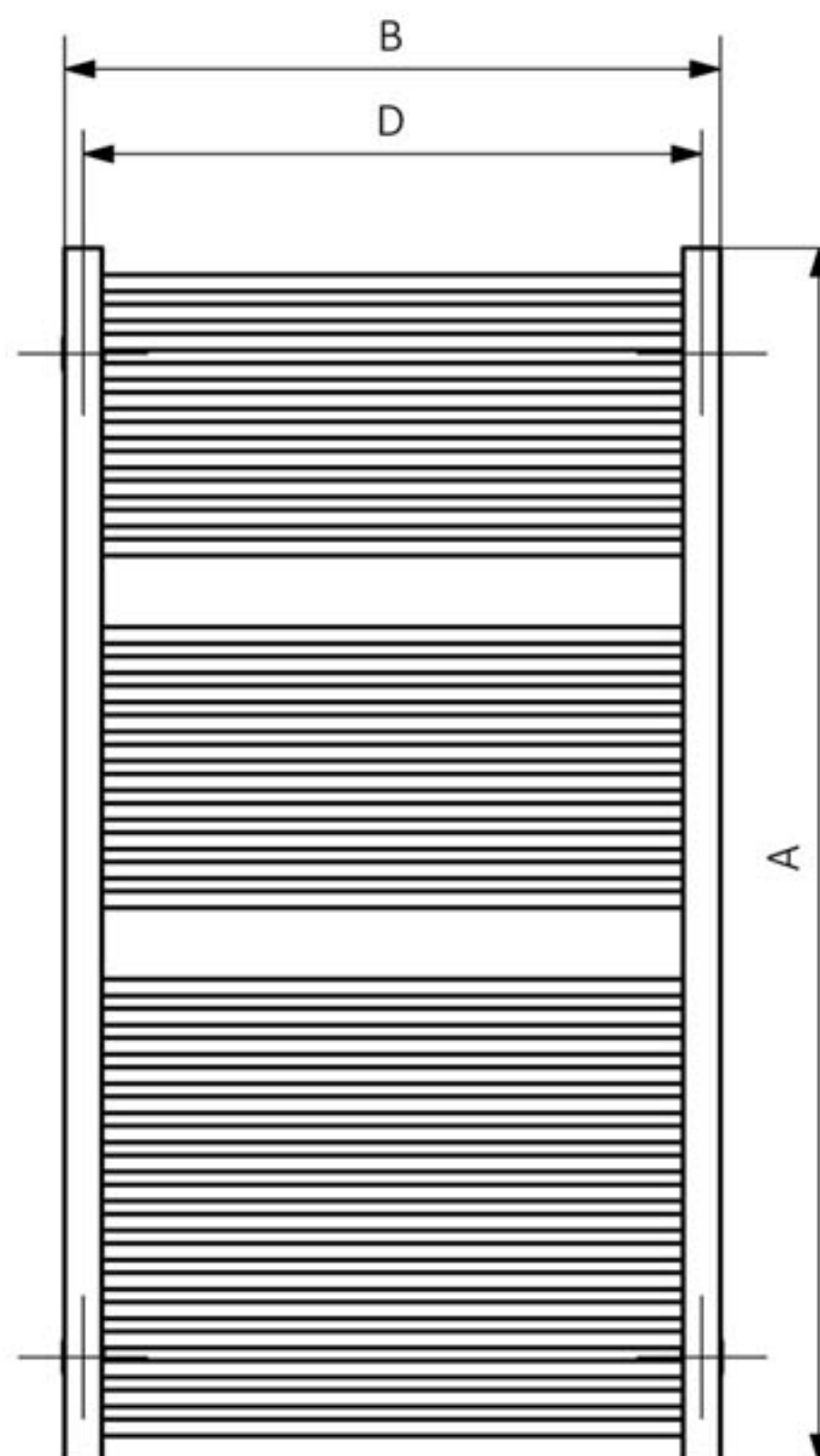
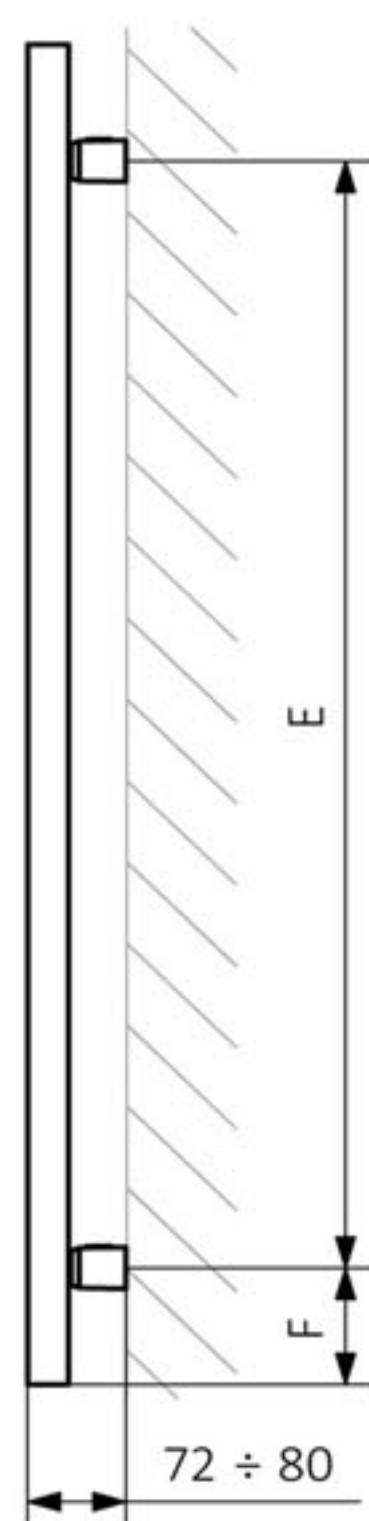
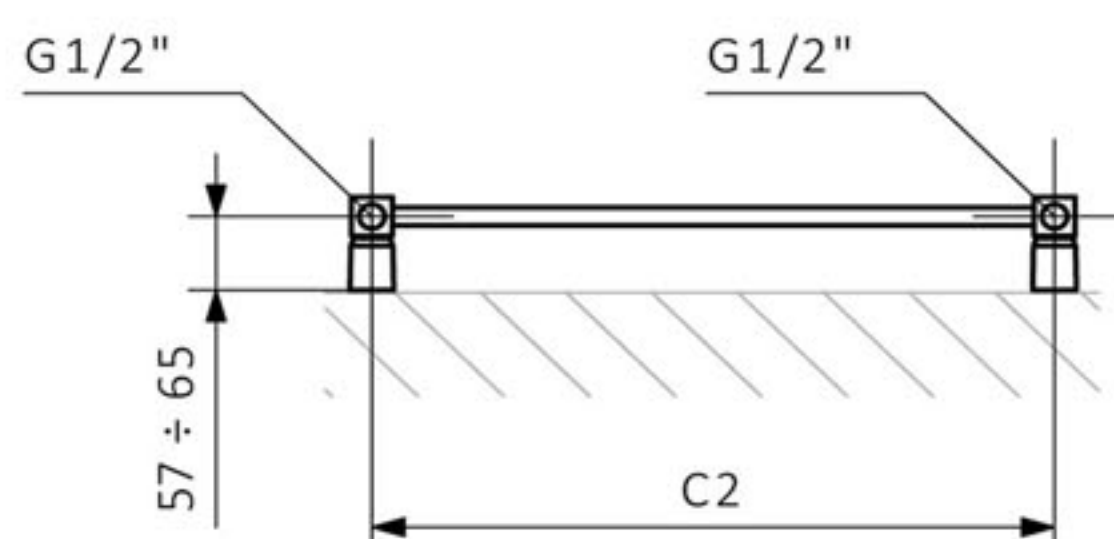

A - Höhe B - Breite C1-C5 - Anschlussabstand D - horizontaler Wandhalterungsabstand E - Vertikaler Wandhalterungsabstand
 F - Abstand von der Achse der unteren Wandhalterung bis Unterkante des Kollektors

Kollektor:

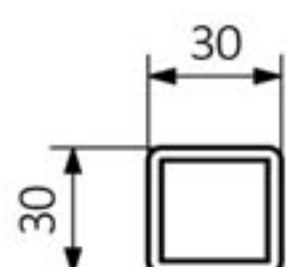

Rohr:

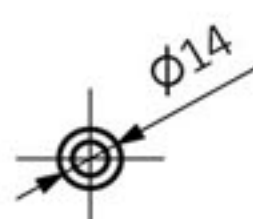

Mike

Preisliste



Modell	Höhe mm.	Breite mm.	Farbe			Premium	Elektrisch mit Heizparone		Chrom
			Farbe	Farbe	Chrom	Elektrisch mit Heizparone	Elektrisch mit Heizparone	Elektrisch mit Heizparone	
			Farbe	Farbe	Chrom	DRY / MEG / MOA	DRY / MEG / MOA	DRY / MEG / MOA	
Mike	435	430	219 €	274 €	438 €	304 €	359 €	523 €	
Mike	435	530	242 €	302 €	504 €	327 €	387 €	589 €	
Mike	460	230	136 €	170 €	337 €	221 €	255 €	422 €	
Mike	710	230	165 €	207 €	437 €	250 €	292 €	522 €	
Mike	735	430	263 €	329 €	636 €	348 €	414 €	721 €	
Mike	735	530	285 €	356 €	701 €	370 €	441 €	786 €	
Mike	960	230	200 €	250 €	543 €	285 €	335 €	628 €	
Mike	1035	430	306 €	383 €	789 €	391 €	468 €	874 €	
Mike	1035	530	330 €	412 €	876 €	415 €	497 €	961 €	
Mike	1210	230	230 €	287 €	644 €	315 €	372 €	729 €	
Mike	1335	430	330 €	412 €	964 €	415 €	497 €	1.049 €	
Mike	1335	530	373 €	466 €	1.095 €	458 €	551 €	1.180 €	
Mike	1460	230	258 €	323 €	743 €	343 €	408 €	828 €	
Mike	1635	430	373 €	466 €	1.139 €	458 €	551 €	1.224 €	
Mike	1635	530	417 €	521 €	1.293 €	502 €	606 €	1.378 €	
Mike	1710	230	287 €	359 €	845 €	372 €	444 €	930 €	

Inkl. 19% MwSt.

zuzüglich 15,00 € Versandkosten.

Gewährleistung: 5 Jahre

Anschlussmöglichkeiten: siehe Datenblatt

Lieferzeit ca. 6 Wochen ab Zahlungseingang

Bei Bestellungen oder Nachfragen, schreiben Sie uns
eine Mail an: info@badheizkoerper-berlin.de

Badheizkörper-Berlin

Gerlinger Str. 34

12349 Berlin

Tel.: +49 (30) 658 30975

Mobil: +49 (177) 248 63 14

info@badheizkoerper-berlin.de

www.badheizkoerper-berlin.de