

Out-Corner

Datenblatt



Standard Anschlussstypen:

A \updownarrow 465÷1545:

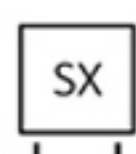

Weitere mögliche Anschlussstypen:

A \updownarrow 465÷1545:

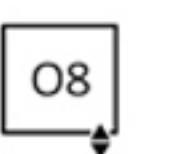
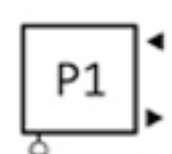
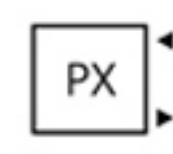
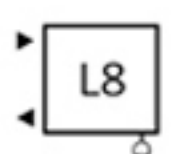
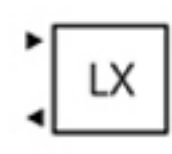

A \updownarrow 735÷1545:

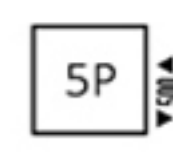

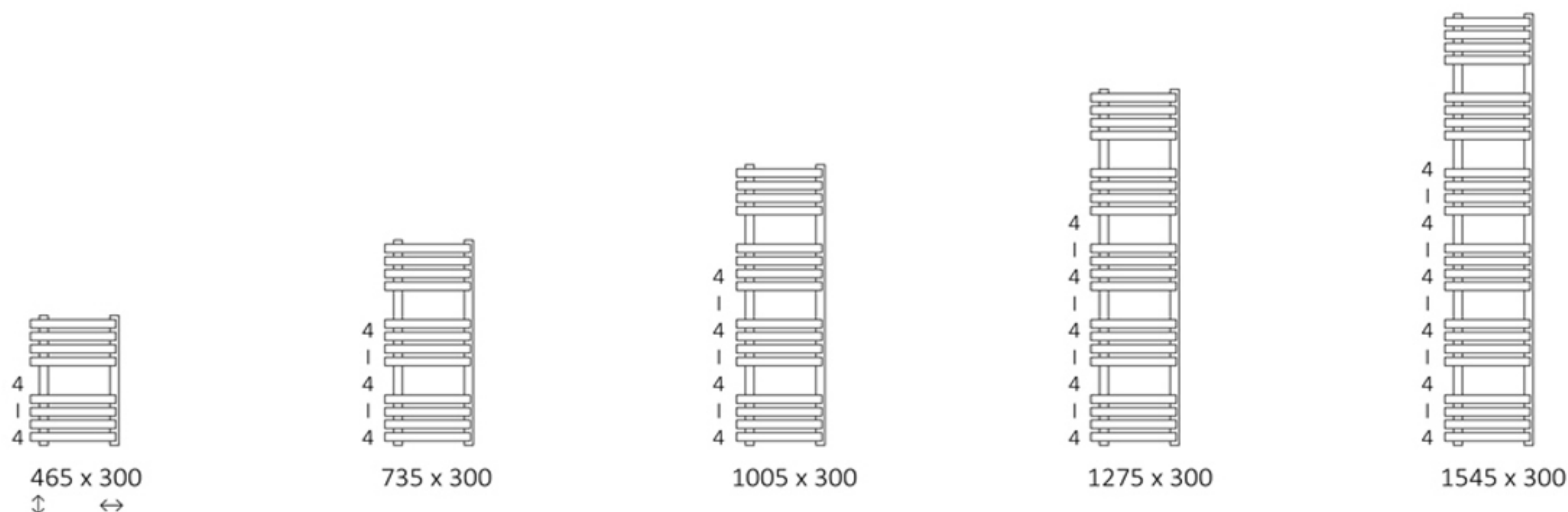

Verfügbare Größen:



Technische Daten:

Betriebsdruck: 1000 kPa

Maximale Betriebstemperatur: 95°C

A \updownarrow [mm]	B \leftrightarrow [mm]	C2 [mm]	75/65/20°C [W]	55/45/20°C [W]	 [W]	D [mm]	E [mm]	F [mm]	 [dm ²]	 [kg]
465	300	195	294	160	300	195	315	76	1,56	5,51
735	300	195	421	228	400	195	585	76	2,39	8,37
1005	300	195	547	294	600	195	855	76	3,22	11,23
1275	300	195	673	361	800	195	1125	76	4,05	14,09
1545	300	195	799	428	800	195	1395	76	4,89	16,95

Out-Corner

Technische Zeichnung



SX

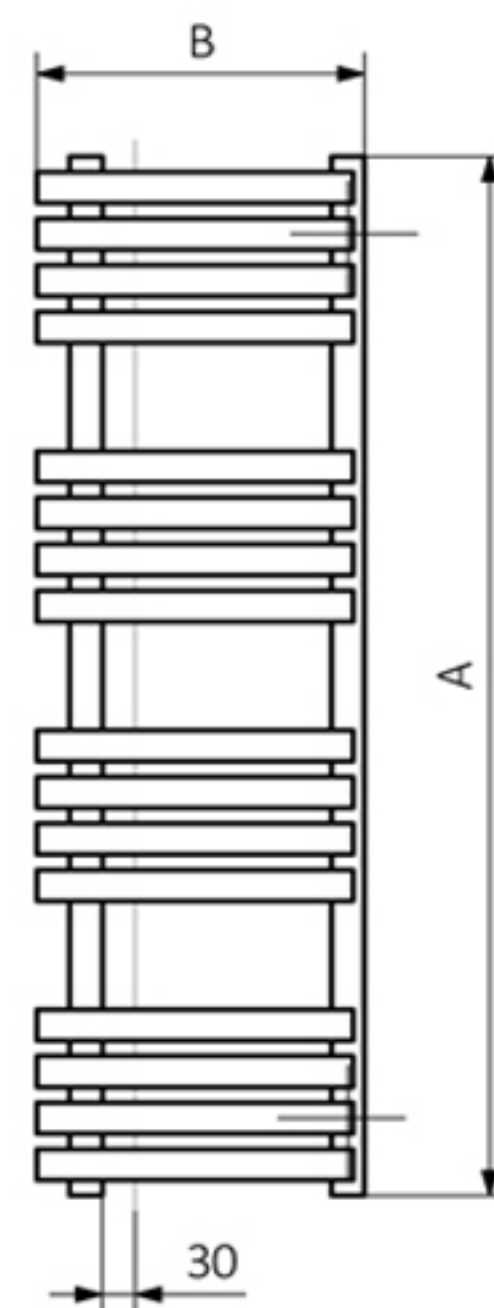
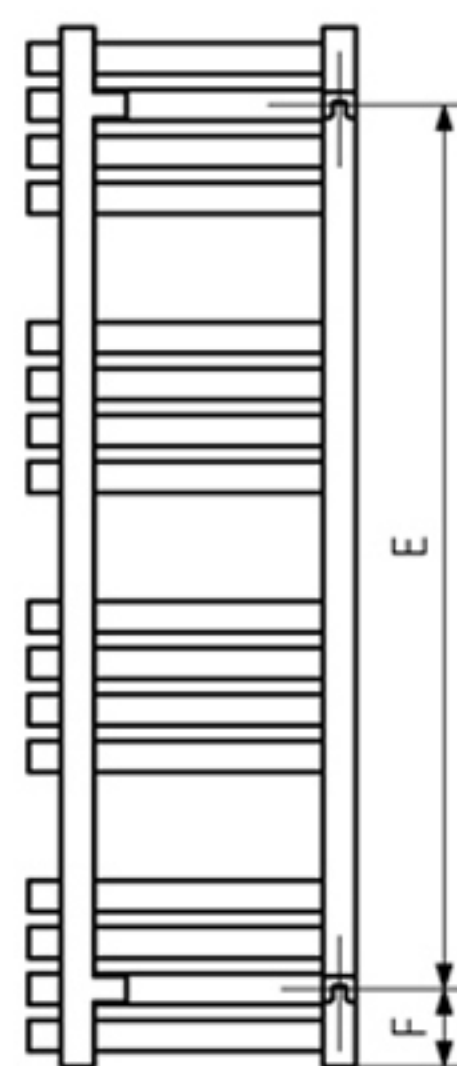
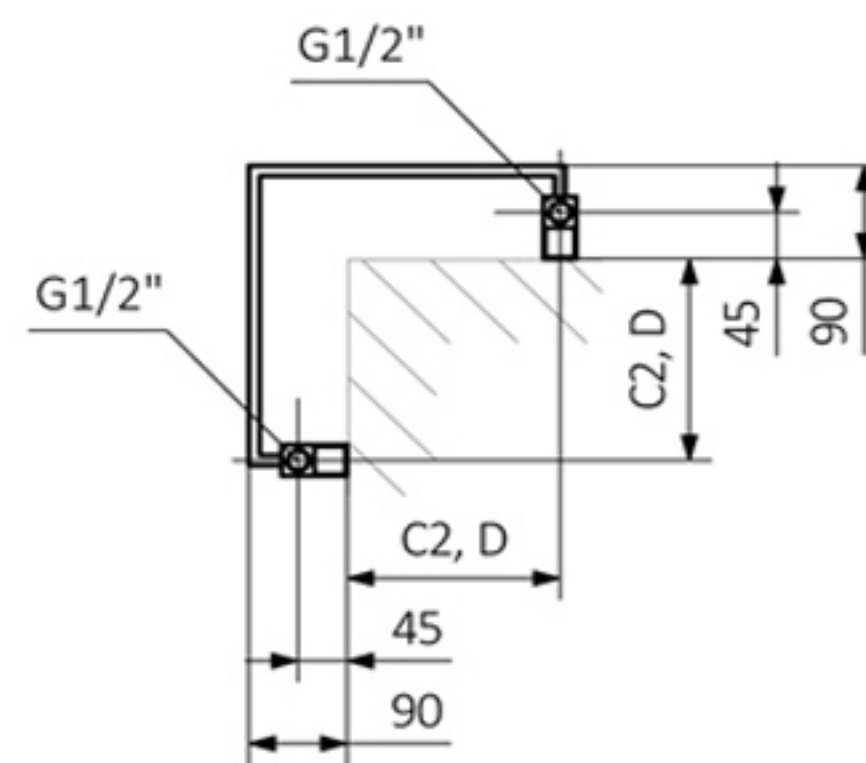

A - Höhe B - Breite C1-C5 - Anschlussabstand D - horizontaler Wandhalterungsabstand E - Vertikaler Wandhalterungsabstand
F - Abstand von der Achse der unteren Wandhalterung bis Unterkante des Kollektors

Kollektor:

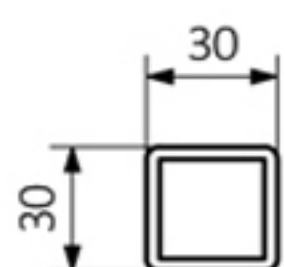

Rohr:

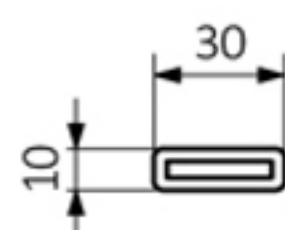

Out-Corner

Preisliste



Modell	Höhe mm.	Breite mm.	Farbe	
			Elektrisch mit Heizparone Farbe	DRY / MEG / MOA
Out-Corner	465	300	390 €	475 €
Out-Corner	735	300	446 €	531 €
Out-Corner	1005	300	501 €	586 €
Out-Corner	1275	300	557 €	642 €
Out-Corner	1545	300	613 €	698 €

Inkl. 19% MwSt.

zuzüglich 15,00 € Versandkosten.

Gewährleistung: 5 Jahre

Anschlussmöglichkeiten: siehe Datenblatt

Lieferzeit ca. 6 Wochen ab Zahlungseingang

Bei Bestellungen oder Nachfragen, schreiben Sie uns
eine Mail an: info@badheizkoerper-berlin.de

Badheizkörper-Berlin

Gerlinger Str. 34

12349 Berlin

Tel.: +49 (30) 658 30975

Mobil: +49 (177) 248 63 14

info@badheizkoerper-berlin.de

www.badheizkoerper-berlin.de