

Lima

Datenblatt 1



Standard Anschlussstypen:

A ↓ 300÷1700:



A ↓ 500÷1700:



Weitere mögliche Anschlussstypen:

A ↓ 300÷1700:

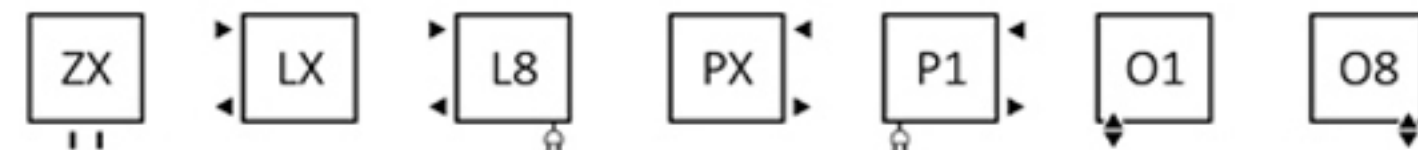

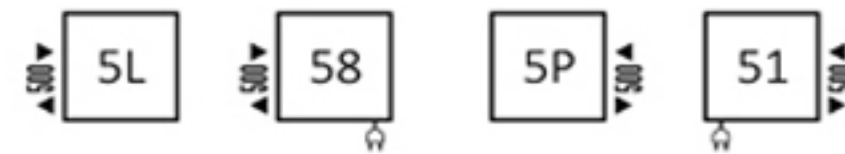

A ↓ 820÷1700:



Technische Daten:

Betriebsdruck: 1000 kPa

Maximale Betriebstemperatur: 95°C

A ↓ [mm]	B ↔ [mm]	C1 [mm]	C2 [mm]	75/65/20°C [W]	55/45/20°C [W]	 [W]	D [mm]	E [mm]	F [mm]	 [dm³]	 [kg]
Pulverlack											
300	1000	50	970	290	159	-	970	120	90	2,43	5,28
300	1200	50	1170	347	191	-	1170	120	90	2,85	6,21
300	1400	50	1370	405	223	-	1370	120	90	3,26	7,15
500	300	50	270	144	79	120	270	320	90	1,50	3,06
500	400	50	370	192	105	200	370	320	90	1,79	3,72
500	500	50	470	241	131	200	470	320	90	2,09	4,39
500	600	50	570	282	153	300	570	320	90	2,39	5,06
500	700	50	670	324	176	300	670	320	90	2,69	5,73
500	1000	50	970	482	262	-	970	320	90	3,59	7,73
500	1200	50	1170	578	314	-	1170	320	90	4,18	9,07
500	1400	50	1370	675	367	-	1370	320	90	4,78	10,41
820	300	50	270	244	132	300	270	640	90	2,53	5,14
820	400	50	370	325	175	300	370	640	90	3,07	6,34
820	500	50	470	406	218	400	470	640	90	3,61	7,54
820	600	50	570	477	256	400	570	640	90	4,15	8,75
820	700	50	670	547	293	600	670	640	90	4,68	9,95
1140	300	50	270	345	185	400	270	960	90	3,57	7,22

Lima

Datenblatt 2



A ↑ [mm]	B ↔ [mm]	C1 [mm]	C2 [mm]	75/65/20°C [W]	55/45/20°C [W]	☼ [W]	D [mm]	E [mm]	F [mm]	H [dm²]	⚖ [kg]
1140	400	50	370	460	247	400	370	960	90	4,35	8,96
1140	500	50	470	574	308	600	470	960	90	5,13	10,69
1140	600	50	570	675	361	800	570	960	90	5,90	12,43
1140	700	50	670	776	415	800	670	960	90	6,68	14,17
1460	300	50	270	449	240	400	270	1280	90	4,66	9,42
1460	400	50	370	599	319	600	370	1280	90	5,68	11,69
1460	500	50	470	748	399	800	470	1280	90	6,69	13,96
1460	600	50	570	879	468	800	570	1280	90	7,71	16,23
1460	700	50	670	1009	537	1000	670	1280	90	8,73	18,50
1700	300	50	270	527	280	600	270	1520	90	5,47	11,04
1700	400	50	370	703	374	800	370	1520	90	6,66	13,71
1700	500	50	470	878	466	800	470	1520	90	7,86	16,38
1700	600	50	570	1031	547	1000	570	1520	90	9,05	19,05
1700	700	50	670	1183	628	1200	670	1520	90	10,25	21,73

Galvanische Oberfläche

300	1000	50	970	203	104	-	970	120	90	2,43	5,07
300	1200	50	1170	243	124	-	1170	120	90	2,85	5,96
300	1400	50	1370	284	145	-	1370	120	90	3,26	6,86
500	300	50	270	101	51	120	270	320	90	1,50	2,94
500	400	50	370	134	69	120	370	320	90	1,79	3,58
500	500	50	470	169	86	200	470	320	90	2,09	4,22
500	600	50	570	197	101	200	570	320	90	2,39	4,86
500	700	50	670	227	116	200	670	320	90	2,69	5,50
500	1000	50	970	337	172	-	970	320	90	3,59	7,43
500	1200	50	1170	405	206	-	1170	320	90	4,18	8,71
500	1400	50	1370	473	241	-	1370	320	90	4,78	9,99
820	300	50	270	171	87	200	270	640	90	2,53	4,94
820	400	50	370	228	116	200	370	640	90	3,07	6,10
820	500	50	470	284	145	300	470	640	90	3,61	7,25
820	600	50	570	334	170	400	570	640	90	4,15	8,40
820	700	50	670	383	195	400	670	640	90	4,68	9,55
1140	300	50	270	242	123	300	270	960	90	3,57	6,94
1140	400	50	370	322	164	300	370	960	90	4,35	8,61
1140	500	50	470	402	205	400	470	960	90	5,13	10,27
1140	600	50	570	473	241	400	570	960	90	5,90	11,94
1140	700	50	670	543	277	600	670	960	90	6,68	13,61
1460	300	50	270	314	160	300	270	1280	90	4,66	9,06
1460	400	50	370	419	214	400	370	1280	90	5,68	11,24
1460	500	50	470	524	267	600	470	1280	90	6,69	13,41
1460	600	50	570	615	314	600	570	1280	90	7,71	15,59
1460	700	50	670	706	360	800	670	1280	90	8,73	17,77
1700	300	50	270	369	188	400	270	1520	90	5,47	10,62
1700	400	50	370	492	251	600	370	1520	90	6,66	13,18
1700	500	50	470	615	313	600	470	1520	90	7,86	15,74
1700	600	50	570	722	368	800	570	1520	90	9,05	18,30
1700	700	50	670	828	422	800	670	1520	90	10,25	20,86

Verfügbare Größen:

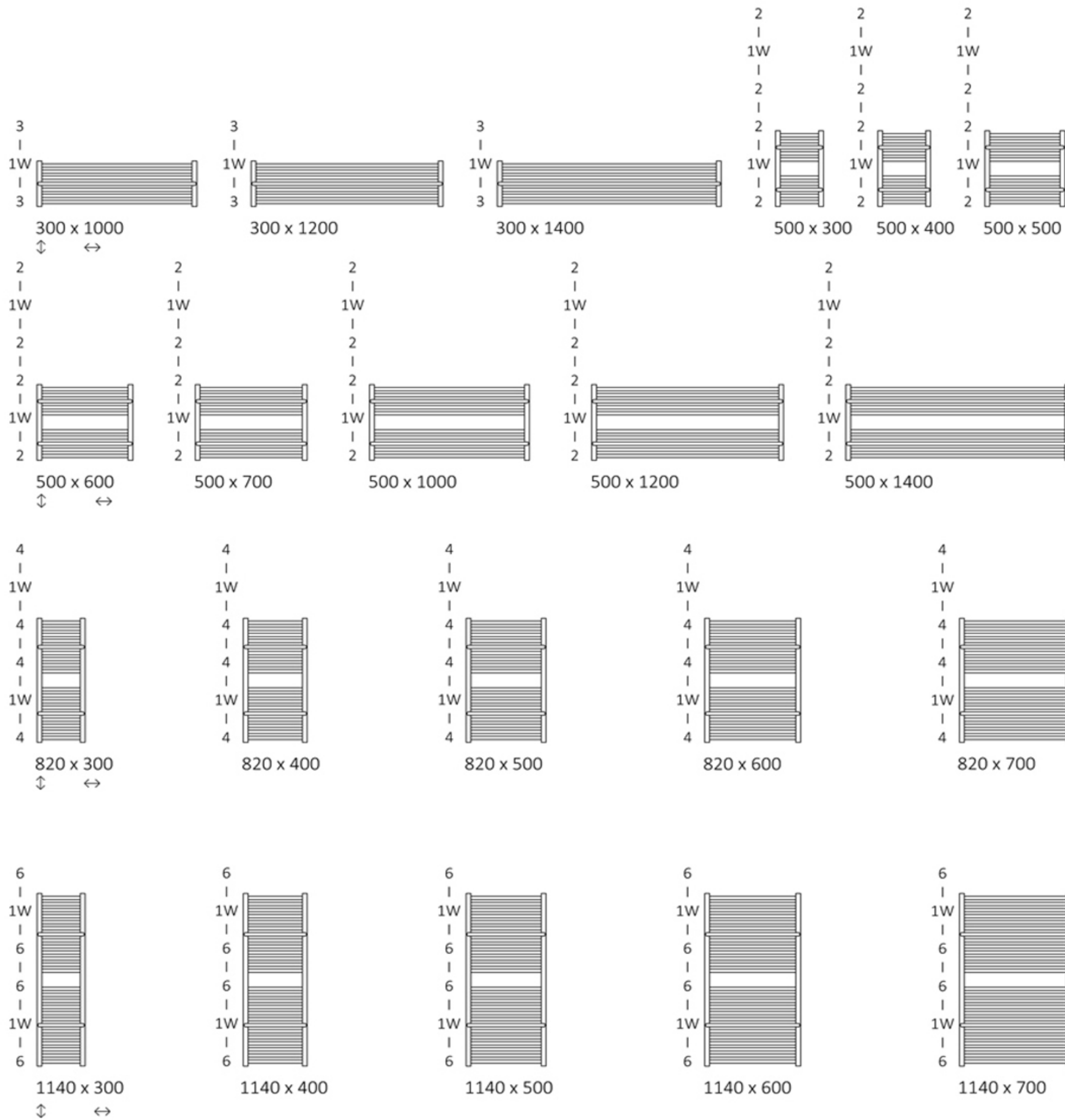

Lima

Datenblatt 4

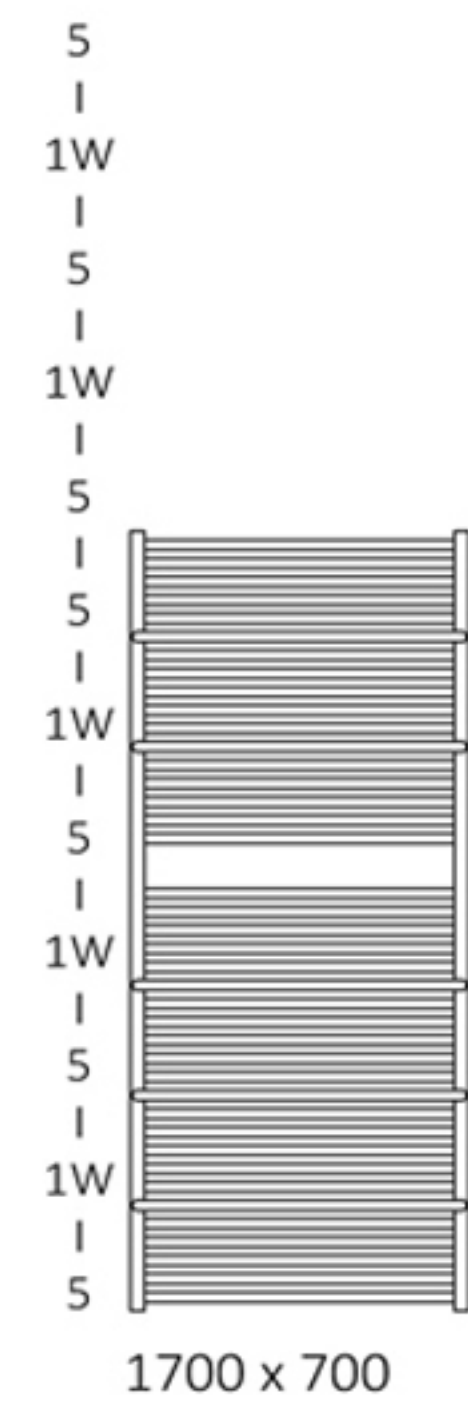
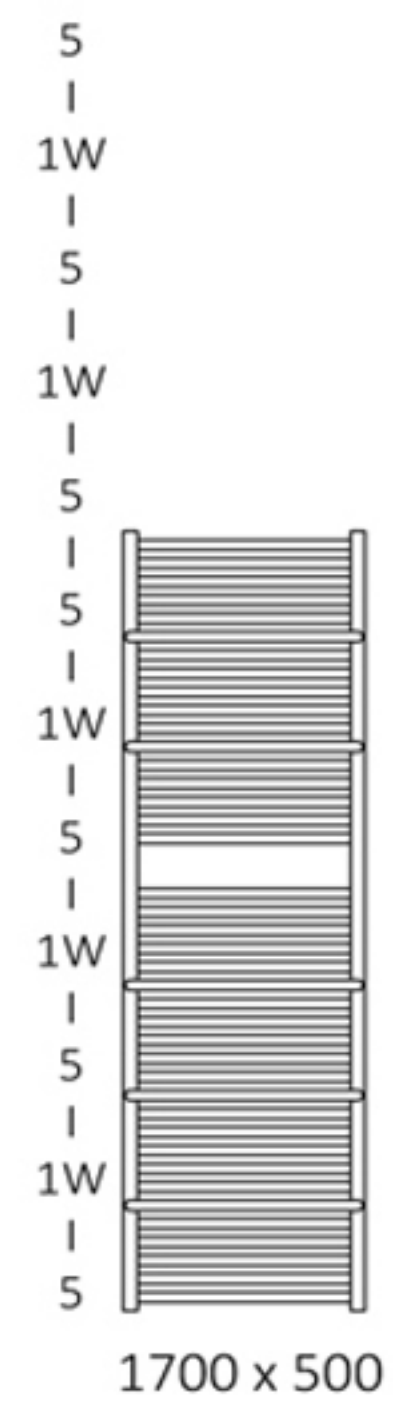
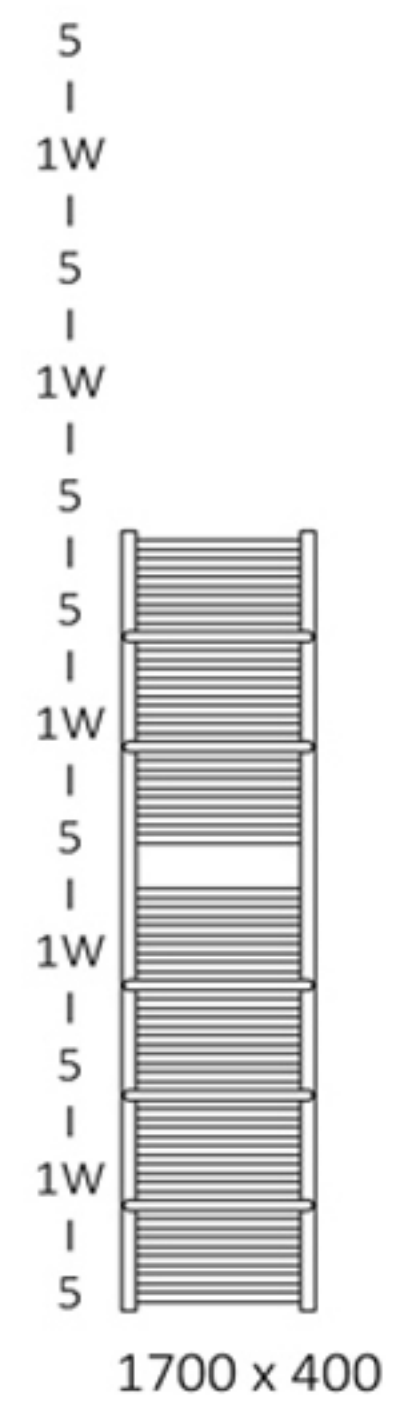
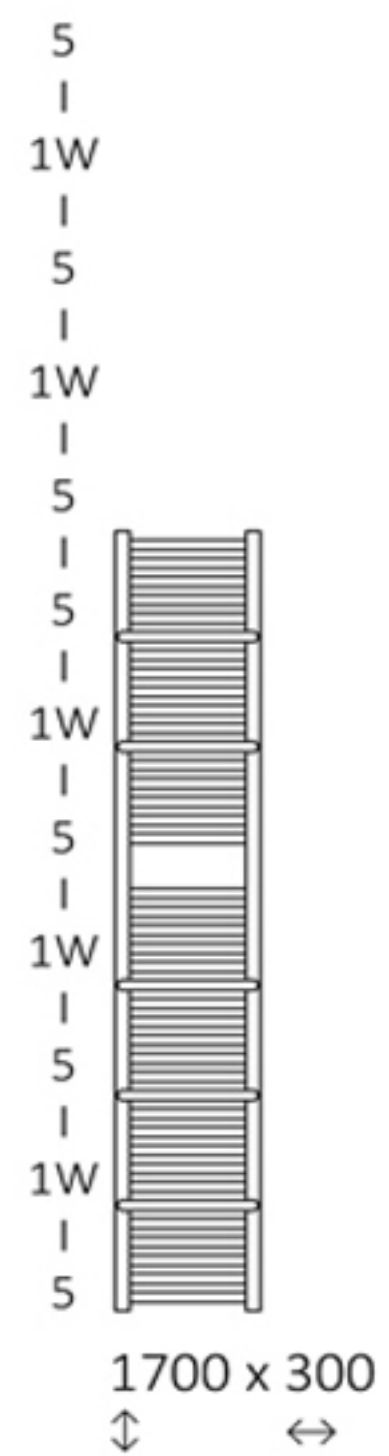
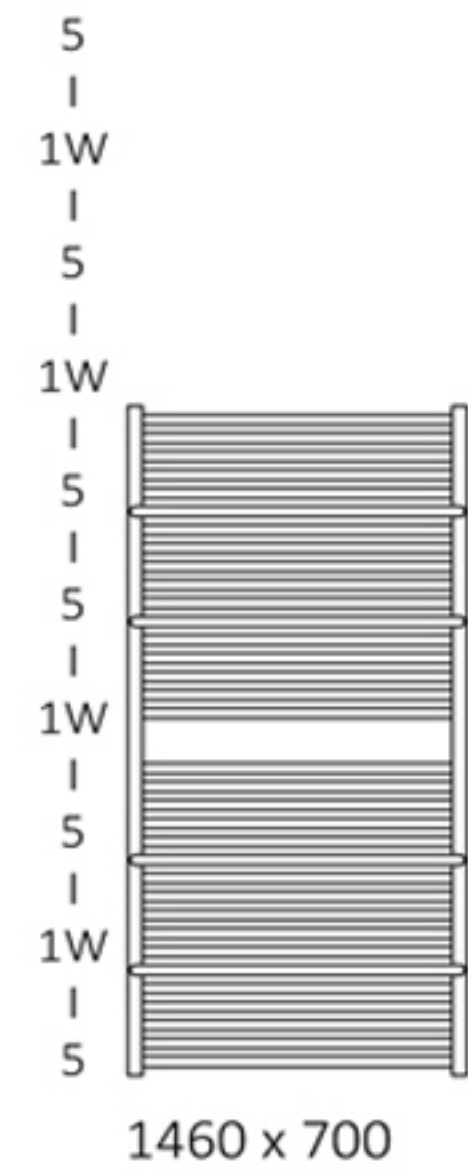
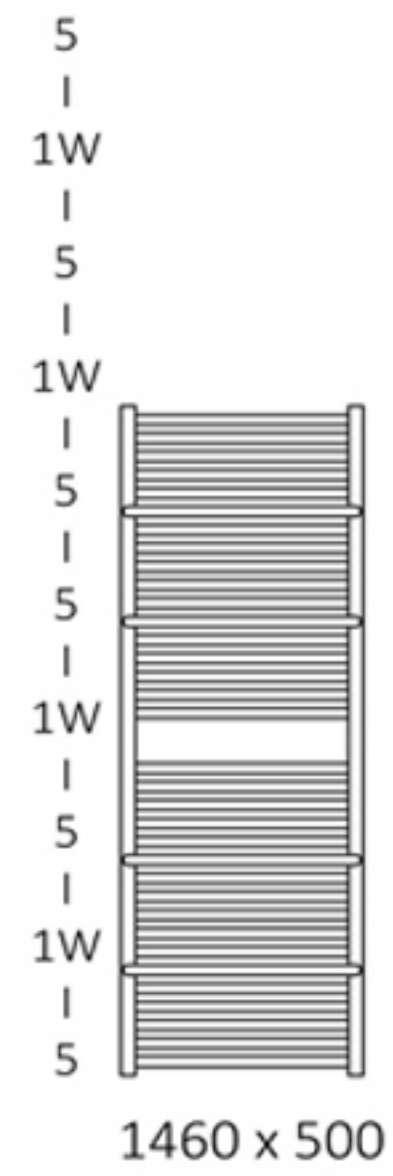
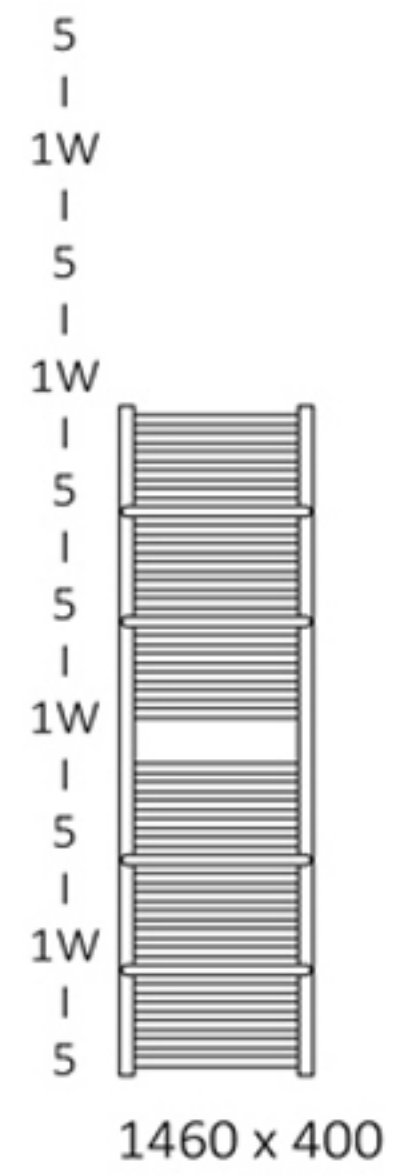
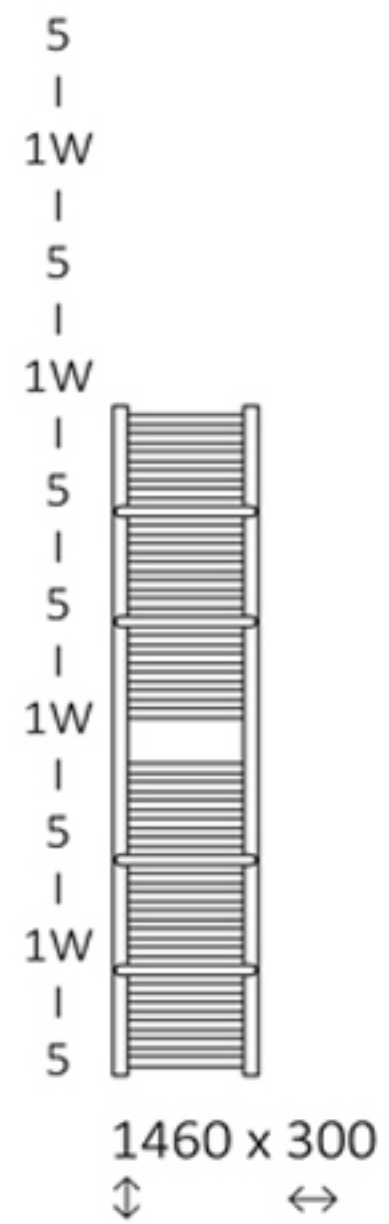

Lima

Technische Zeichnung

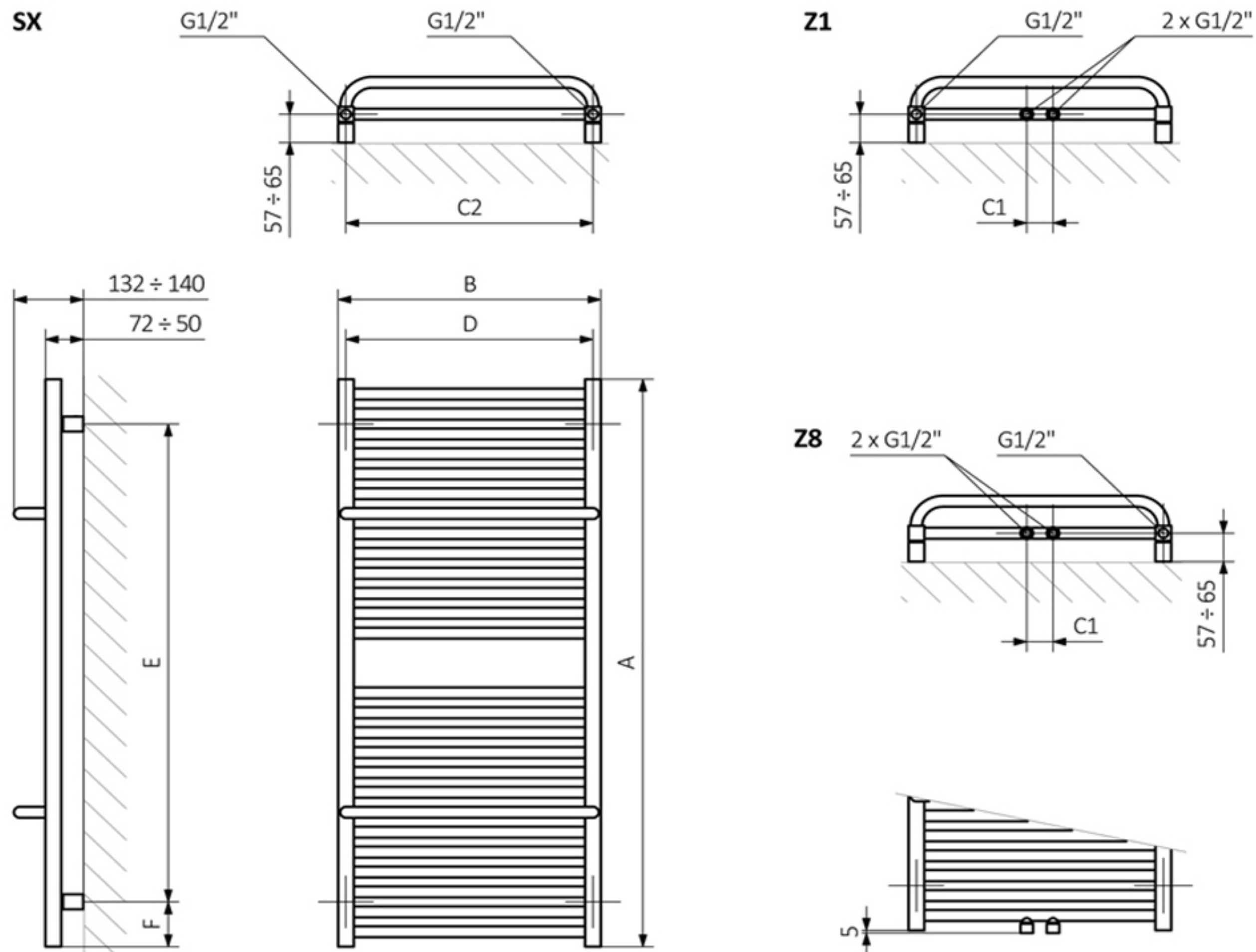

A - Höhe B - Breite C1-C5 - Anschlussabstand D - horizontaler Wandhalterungsabstand E - Vertikaler Wandhalterungsabstand F - Abstand von der Achse der unteren Wandhalterung bis Unterkante des Kollektors

Kollektor:

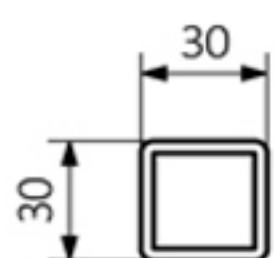

Rohr:

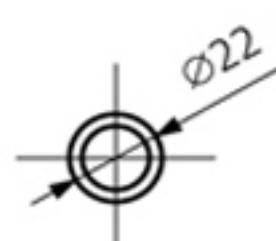

Lima

Preisliste



Modell	Höhe mm.	Breite mm.	Premium			Farbe RAL Farbpalette			Premium Farbe			Chrom		
			Elektrisch mit Heizparone			Elektrisch mit Heizparone			Elektrisch mit Heizparone			Elektrisch mit Heizparone		
			Farbe	Farbe	Chrom	DRY / MEG / MOA	DRY / MEG / MOA	DRY / MEG / MOA	DRY / MEG / MOA	DRY / MEG / MOA	DRY / MEG / MOA	DRY / MEG / MOA	DRY / MEG / MOA	DRY / MEG / MOA
Lima	300	1000	201 €	251 €	553 €									
Lima	300	1200	217 €	272 €	575 €									
Lima	300	1400	230 €	288 €	619 €									
Lima	500	300	147 €	183 €	509 €	232 €			268 €			594 €		
Lima	500	400	155 €	194 €	531 €	240 €			279 €			616 €		
Lima	500	500	167 €	209 €	553 €	252 €			294 €			638 €		
Lima	500	600	185 €	231 €	597 €	270 €			316 €			682 €		
Lima	500	700	188 €	235 €	619 €	273 €			320 €			704 €		
Lima	500	1000	209 €	261 €	641 €									
Lima	500	1200	231 €	288 €	708 €									
Lima	500	1400	251 €	314 €	774 €									
Lima	820	300	185 €	231 €	597 €	270 €			316 €			682 €		
Lima	820	400	196 €	245 €	619 €	281 €			330 €			704 €		
Lima	820	500	209 €	261 €	641 €	294 €			346 €			726 €		
Lima	820	600	226 €	283 €	664 €	311 €			368 €			749 €		
Lima	820	700	251 €	314 €	708 €	336 €			399 €			793 €		
Lima	1140	300	230 €	288 €	664 €	315 €			373 €			749 €		
Lima	1140	400	247 €	309 €	686 €	332 €			394 €			771 €		
Lima	1140	500	272 €	340 €	708 €	357 €			425 €			793 €		
Lima	1140	600	293 €	366 €	752 €	378 €			451 €			837 €		
Lima	1140	700	318 €	398 €	819 €	403 €			483 €			904 €		
Lima	1460	300	251 €	314 €	752 €	336 €			399 €			837 €		
Lima	1460	400	272 €	340 €	774 €	357 €			425 €			859 €		
Lima	1460	500	293 €	366 €	796 €	378 €			451 €			881 €		
Lima	1460	600	314 €	392 €	841 €	399 €			477 €			926 €		
Lima	1460	700	360 €	450 €	885 €	445 €			535 €			970 €		
Lima	1700	300	314 €	392 €	819 €	399 €			477 €			904 €		
Lima	1700	400	335 €	419 €	841 €	420 €			504 €			926 €		
Lima	1700	500	356 €	445 €	885 €	441 €			530 €			970 €		
Lima	1700	600	392 €	491 €	973 €	477 €			576 €			1.058 €		
Lima	1700	700	439 €	549 €	1.061 €	524 €			634 €			1.146 €		

Inkl. 19% MwSt.

zuzüglich 15,00 € Versandkosten.

Gewährleistung: 5 Jahre

Anschlussmöglichkeiten: siehe Datenblatt

Lieferzeit ca. 6 Wochen ab Zahlungseingang

Bei Bestellungen oder Nachfragen, schreiben Sie uns
eine Mail an: info@badheizkoerper-berlin.de

Badheizkörper-Berlin

Gerlinger Str. 34

12349 Berlin

Tel.: +49 (30) 658 30975

Mobil: +49 (177) 248 63 14

info@badheizkoerper-berlin.de

www.badheizkoerper-berlin.de